

## 1inch Format for High Resolution Lenses

Item No.	Focal Length	Iris Range	Angle of View ( H x V x D )	M.O.D	Filter Thread	Dimention(DxL)	Weight
GMHR48014MCN	8.0mm	F1.4-16	1" 79°7'x63°0'x92°4'	0.1m	M=55.0 , P=0.75	Ø57 x 58mm	250g
GMHR412513MCN	12.5mm	F1.3-16	1" 54°5'x41°9'x65°4'	0.23m	M=40.5 , P=0.5	Ø49 x 57mm	160g
GMHR412514MCN	12.5mm	F1.4-16	1" 55°6'x42°5'x67°7'	0.3m	M=35.5 , P=0.5	Ø42 x 52mm	150g
GMHR41614MCN	16.0mm	F1.4-16	1" 44°3'x33°6'x54°4'	0.3m	M=35.5 , P=0.5	Ø42 x 53mm	140g
GMHR42514MCN	25.0mm	F1.4-16	1" 29°3'x22°0'x36°6'	0.3m	M=35.5 , P=0.5	Ø42 x 43mm	125g
GMHR43514MCN	35.0mm	F1.4-16	1" 20°9'x15°8'x26°1'	0.3m	M=35.5 , P=0.5	Ø42 x 43mm	130g
GMHR45013MCN	50.0mm	F1.3-16	1" 13°8'x10°4'x17°2'	0.43m	M=49 , P=0.5	Ø62 x 50.5mm	-g
GMHR45014MCN	50.0mm	F1.4-16	1" 14°5'x10°8'x18°0'	0.5m	M=40.5 , P=0.5	Ø48 x 48mm	200g
GMHR47513MCN	75.0mm	F1.3-32	1" 9°45'x7°12'x11°9'	0.9m	M=62 , P=0.75	Ø65 x 69mm	-g
GMHR47518MCN	75.0mm	F1.4-16	1" 9°7'x7°3'x12°0'	0.5m	M=46.0 , P=0.75	Ø48 x 57mm	180g

## High Resolution Megapixel Varifocal zoom Lenses

Item No.	Focal Length	Iris Range	Angle of View (HxVxD)	M.O.D	FilterThread	Dimention (WxHxL)	Weight
GMMPZ4411MCN	4.4-11 mm	F1.6-16	1/1.8" 36°7'x28°0'x44°8' - 76°6'x61°2'x89°4'	0.3m	M=43 , P=0.75	Ø45 x 56.5mm	125g
GMMPZ1040MCN	10-40 mm	F1.6-16	1/1.8" 10°5'x7°9'x13°1' - 39°5'x22°5'x48°3'	0.5m	M49 , P=0.75	Ø51x107mm	290g
GMMPZ20100MCN	20-100 mm	F1.8-14	1/1.8" 20°4'x15°4'x25°3' - 4°2'x3°2'x5°2'	0.5m	M49 , P=0.75	Ø51x120mm	350g
GMMPZ1664MCN	16-64 mm	F1.8-16	1" 11°7'x8°8'x14°6' - 45°9'x34°2'x57°9'	1.0m	M=58 , P=0.75	Ø60 x 125mm	375g

## High Resolution 10Megapixel Lenses

Item No.	Focal Length	Iris Range	Angle of View (HxVxD)	M.O.D	FilterThread	Dimention (WxHxL)	Weight
GM10HR31218MCN	12 mm	F1.8-11	2/3" 39°1'x29°8'x47°8'	0.1m	M25.5 , P=0.5	Ø33 x 53.5mm	105g

## High Resolution 5Megapixel Lenses

Item No.	Focal Length	Iris Range	Angle of View (HxVxD)	M.O.D	FilterThread	Dimention (WxHxL)	Weight
GMB5HR30528MCN	5 mm	F2.8-16	2/3" 82°4'x66°9'	0.1m	M40.5 , P=0.5	Ø42 x 38.5mm	90g
GMB5HR38014MCN	8 mm	F1.4-Close	2/3" 56°5'x43°9'x67°0'	0.1m	M30.5 , P=0.5	Ø38.5 x 41.6mm	105g
GMA5HR38028MCN	8 mm	F2.8-22	2/3" 57°9'x45°0'	0.1m	M49.0 , P=0.75	Ø51 x 48.5mm	210g
GM5HR39014MCN	9 mm	F1.4-Close	2/3" 50°8'x39°3'x61°5' - 38°2'x29°1'x57°3'	0.1m	M=46 , P=0.75	Ø48 x 54mm	160g
GMA5HR31218MCN	12mm	F1.8-22	2/3" 40°3'x30°8'	0.15m	M=49 , P=0.75	Ø51 x 59.0mm	200g
GM5HR31614MCN	16 mm	F1.4-22	2/3" 30°7'x23°3'	0.2m	M=49 , P=0.75	Ø51 x 62.5mm	200g
GMB5HR31614MCN	16 mm	F1.4-16	2/3" 30°0'x22°7'x37°0'	0.2m	M30.5 , P=0.5	Ø38.5 x 39.1mm	85g
GM5HR32514MCN	25 mm	F1.4-22	2/3" 43°3'x33°0'	0.2m	M=49 , P=0.75	Ø51 x 48.0mm	190g
GMB5HR32514MCN	25 mm	F1.4-16	2/3" 19°6'x14°8'x24°3'	0.2m	M30.5 , P=0.5	Ø38.5 x 44.0mm	90g
GM5HR33514MCN	35 mm	F1.4-22	2/3" 10°4'x7°8'	0.25m	M=49 , P=0.75	Ø51 x 62.0mm	230g
GMB5HR35028MCN	50 mm	F2.8-22	2/3" 9°6'x7°2'x11°9'	0.2m	M30.5 , P=0.5	Ø38.5 x 76.0mm	120g

## 1 Inch Format Lenses

Item No.	Focal Length	Iris Range	Angle of View (HxVxD)	M.O.D	FilterThread	Dimention (WxHxL)	Weight
GM42514MC	25.0mm	F1.4-Close	27°8'x20°9'x34°8'	0.5m	M=43 , P=0.75	Ø46 x 28mm	81g
GMG42514MCN	25.0mm	F1.4-Close	28°7'x21°7'x36°0'	0.5m	M=34 , P=0.5	Ø36.5 x 37mm	90g
GM45018MC	50.0mm	F1.8-Close	14°8'x11°1'x18°6'	1.0m	M=40.5 , P=0.5	Ø44 x 48.5mm	145g
GMG45018MCN	50.0mm	F1.8-Close	14°5'x10°9'x18°0'	0.7m	M=40.5 , P=0.5	Ø46 x 42.5mm	150g
GMG47518MCN	75.0mm	F1.8-Close	9°7'x7°3'x12°3'	0.8m	M=46 , P=0.75	Ø48.0 x 58.5mm	250g

## Standard Manual Lenses

Item No.	Focal Length	Iris Range	Angle of View ( H x V x D )		M.O.D	Filter Thread	Dimention (DxL)	Weight
			1/2"	2/3"				
GM23514MCN	3.5mm	F1.4-Close	103°6'x76°0'x132°1'		0.2m		Ø31 x 30.5mm	73g
GM23514MCN-1	3.5mm	F1.4-Close	103°6'x76°0'x132°1'		0.1m		Ø30 x 31.5mm	75g
GM24514MCN	4.5mm	F1.4-Close	79°0'x59°4'x98°2'		0.2m		Ø31 x 29.5mm	71g
GM26014MCN	6.0mm	F1.4-Close	54°35'x42°19'x65°39'		0.2m	M=27.0 , P=0.5	Ø30 x 30.0mm	57g
GMN36014MCN-1	6.0mm	F1.4-16	59°4'x44°5'x74°3'	81°9'x61°2'x102°9'	0.1m		Ø30 x 33.0mm	65g
GM38013MCN-1	8.0mm	F1.3-Close	42°0'x32°7'x50°3'	57°8'x45°0'x69°2'	0.2m	M=25.5 , P=0.5	Ø30 x 34.5mm	60g
GMN38014MCN-1	8.0mm	F1.4-16	46°2'x34°6'x58°1'	64°2'x47°7'x81°3'	0.1m	M=27.0 , P=0.5	Ø30 x 30.0mm	55g
GM21214MCN	12.0mm	F1.4-Close	28°58'x21°56'x35°49'		0.3m	M=27.0 , P=0.5	Ø30 x 34.5mm	56g
GMN31214MCN-1	12.0mm	F1.4-16	30°7'x23°0'x38°5'	42°5'x31°7'x53°7'	0.1m	M=27.0 , P=0.5	Ø30 x 31.5mm	55g
GM31614MCN	16.0mm	F1.4-Close	22°2'x16°5'x27°58'	30°22'x23°0'x38°6'	0.4m	M=27.0 , P=0.5	Ø30 x 24.5mm	40g
GMN31614MCN-1	16.0mm	F1.4-16	22°2'x16°5'x27°5"	30°5'x22°8'x38°3'	0.2m	M=27.0 , P=0.5	Ø30 x 28.0mm	40g
GM32514MCN	25.0mm	F1.4-Close	14°3'x10°5'x18°11'	19°5'x15°1'x25°2'	0.5m	M=27.0 , P=0.5	Ø30 x 24.5mm	50g
GMN32516MCN-1	25.0mm	F1.6-16	15°3'x11°4'x19°1'	21°0'x15°7'x26°3'	0.2m	M=27.0 , P=0.5	Ø30 x 28.5mm	50g
GM23512MCN	35.0mm	F1.2-Close	10°4'x7°8'x12°1'		1.0m	M=40.5 , P=0.5	Ø46 x 43.0mm	150g
GM33519MCN	35.0mm	F1.9-Close	10°5'x7°9'x13°1'	14°4'x10°8'x17°9'	0.5m	M=27.0 , P=0.5	Ø30 x 28.0mm	50g
GMN33516MCN-1	35.0mm	F1.6-16	10°5'x7°9'x13°1'	14°4'x10°8'x17°9'	0.35m	M=30.5 , P=0.5	Ø32 x 36.5mm	75g
GM35018MCN	50.0mm	F1.8-Close	7°4'x5°4'x9°3'	10°3'x7°5'x13°0'	1.0m	M=30.5 , P=0.5	Ø32 x 37.3mm	55g
GMN35020MCN-1	50.0mm	F2.0-16	7°3'x5°5'x9°2'	10°1'x7°5'x12°5'	0.5m	M=30.5 , P=0.5	Ø32 x 40.0mm	75g
GMT35018MCN	50.0mm	F1.8-Close	8°1'x6°2'x9°9'	11°0'x8°3'x13°3'	0.7m	M=30.5 , P=0.5	Ø32 x 34.0mm	55g
GM37527MCN	75.0mm	F2.7-Close	4°46'x3°34'x5°58'	6°33'x4°55'x8°12'	1.0m	M=30.5 , P=0.5	Ø32 x 42.5mm	55g
GMN37525MCN-1	75.0mm	F2.5-16	4°9'x3°7'x6°1'	6°7'x5°0'x8°3'	1.2m	M=34.0 , P=0.5	Ø36 x 51.0mm	90g
GM310035MCN	100.0mm	F3.5-Close	3°47'x2°51'x4°42'	5°9'x3°54'x6°21'	1.0m	M=30.5 , P=0.5	Ø32 x 44.2mm	59g
GMN310028MCN-1	100.0mm	F2.8-16	3°7'x2°8'x4°6'	5°7'x3°8'x6°3'	2.0m	M=40.5 , P=0.5	Ø42 x 70.0mm	140g

## High Resolution Lenses (for the Megapixel Cameras)

Item No.	Focal Length	Iris Range	Angle of View ( H x V x D )		M.O.D	Filter Thread	Dimention (DxL)	Weight
			1/2"	2/3"				
GMHR23524MCN	3.5mm	F2.4-16.0	82°4'x66°9'		0.1m	M=40.5 , P=0.5	Ø42 x 38.2mm	85g
GMHR26012MCN	6.0mm	F1.2-16.0	56°2'x43°5'x67°0'		0.1m	M=30.5 , P=0.5	Ø34 x 46mm	110g
GMHR26014MCN	6.0mm	F1.4-16.0	57°4'x44°3'x72°9'		0.2m	M=30.5 , P=0.5	Ø32 x 37.5mm	70g
GMTHR21614MCN	16.0mm	F1.4-16.0	Ø8.8, 24°x18°x29°7'		0.3m	M=25.5 , P=0.5	Ø29 x 31.5mm	50g
GMHR30528MCN	5.0mm	F2.8-16.0		82°4'x66°9'	0.1m	M=40.5 , P=0.5	Ø42 x 38.2mm	85g
GMHR38014MCN	8.0mm	F1.4-Close	42°6'x32°5'x52°1'	56°5'x43°9'x67°0'	0.1m	M=27.5 , P=0.5	Ø34 x 41mm	83g
GMHR31214MCN	12.0mm	F1.4-Close	28°3'x21°1'x35°0'	38°3'x26°2'x46°8'	0.15m	M=27.0 , P=0.5	Ø34 x 37mm	75g
GMHR31614MCN	16.0mm	F1.4-Close	21°8'x16°4'x27°0'	30°0'x22°7'x37°0'	0.2m	M=25.5 , P=0.5	Ø33 x 37.0mm	85g
GMHR32514MCN	25.0mm	F1.4-Close	14°0'x10°5'x17°5'	19°6'x14°8'x24°3'	0.2m	M=27.0 , P=0.5	Ø33 x 40.0mm	90g
GMTHR32514MCN	25.0mm	F1.4-16.0	14°6'x11°0'x18°2'	20°1'x15°1'x25°0'	0.25m	M=25.5 , P=0.5	Ø29 x 32.0mm	50g
GMHR33520MCN	35.0mm	F2.0-16.0	10°5'x7°8'x13°1'	14°4'x10°8'x17°9'	0.2m	M=27.0 , P=0.5	Ø34 x 36mm	95g
GMTHR33520MCN	35.0mm	F2.0-22.0	10°5'x7°9'x13°1'	14°3'x10°5'x17°8'	0.25m	M=25.5 , P=0.5	Ø29 x 39mm	60g
GMHR35028MCN	50.0mm	F2.8-Close	7°0'x5°2'x8°7'	9°6'x7°2'x11°9'	0.2m	M=27.0 , P=0.5	Ø34 x 55.0mm	95g
GMTHR35028MCN	50.0mm	F2.8-22	7°3'x5°5'x9°0'	10°0'x7°5'x12°4'	0.5m	M=25.5 , P=0.75	Ø29 x 39.0mm	95g

## F0.95 Lenses

Item No.	Focal Length	Iris Range	Angle of View (HxVxD)		M.O.D	Filter Thread	Dimention (WxHxL)	Weight
GMY31795MC	17.0mm	F0.95-16	2/3"	21°3'x16°1'x26°5'	0.5m	M=40.5 , P=0.5	Ø42 x 63.5mm	165g
GMY42595MC	25.0mm	F0.95-16	1"	28°7'x21°7'x35°5'	0.5m	M=40.5 , P=0.5	Ø42 x 45.5mm	165g
GMV42595MC	25.0mm	F0.95-16	1"	28°6'x21°7'x35°2'	0.4m	M=40.5 , P=0.5	Ø46 x 47.0mm	145g
GMV45095MC	50.0mm	F0.95-16	1"	14°6'x11°0'x18°2'	0.6m	M=62 , P=0.75	Ø65 x 74.5mm	470g

## Manual Vari-Focal Zoom Lenses

Item No.	Focal Length	Iris Range	Angle of View (HxVxD)	M.O.D	FilterThread	Dimension (WxHxL)	Weight
GM16539MSN	6.5-39mm	F1.4-Close	1/3" 40°x31° - 7°x5°5'	0.8m	M=37.5 , P=0.5	Ø44 x 73.0mm	125g
GM150100MSN	5-100mm	F1.6-16	1/3" 52°7'x40°0'x64°6' - 2°8'x2°1'x3°5'	0.3m	M=46.0 , P=0.75	Ø48 x 93mm	200g
GM26012MCN	6-12mm	F1.4-Close	1/2" 56°10'x43°60'x67°40' - 29°90'x22°60'x36°90'	0.3m	M=35.5 , P=0.5	Ø40 x 54.5mm	104g
GM26015MCN	6-15mm	F1.4-Close	1/2" 59°13'x44°06'x74°49' - 25°65'x19°23'x32°08'	0.3m	M=37.5 , P=0.75	Ø40 x 59mm	120g
GM26552MCN	6.5-22mm	F1.8-Close	1/2" 55°0'x41°2'x68°6' - 7°2'x5°4'x8°9'	0.2m	M=43.0 , P=0.75	Ø46 x 73.5mm	170g
GM28551MCN	8.5-51mm	F1.4-Close	1/2" 31°x23° - 5°5'x4°5'	0.8m	M=37.5 , P=0.5	Ø44 x 78mm	125g
GM29090MCN	9-90mm	F1.8-16	1/2" 41°1'x30°3'x52°6' - 4°2'x3°1'x5°2'	0.3m	M=46 , P=0.75	Ø45 x 93mm	200g

## Manual Zoom Lenses

Item No.	Focal Length	Iris Range	Angle of View (HxVxD)	M.O.D	FilterThread	Dimension (WxHxL)	Weight
GMZ8590056MCN	8.5-90mm	F5.6-16	1/3" 173mmx129mm- 7.9mmx6.2mm	290-135mm	M=43.0, P=0.75	Ø54 x 128mm	320g
GMZ85900MCN	8.5-90mm	F2.5-Close	1/3" 172mmx128mm - 6.9mmx5.2mm	310-150mm	M=48.0, P=0.75	Ø60 x 138mm	450g
GMZ18108	18-108mm	F2.5-16	2/3" 27°2'x20°4'x34°0' - 4°6'x3°5'x5°8'	120-330mm	M=52, P=0.75	Ø62 x 172mm	580g
GMZ8048010MCN	8-48mm	F1.0-Close	1/2" 43°6'x33°4'x54°92' - 7°7'x5°7'x9°58'	1.0m	M=46 , P=0.75	Ø58 x 102.4mm	395g
GMZ80800MCN	8-80mm	F1.4-Close	1/2" 44°09'x33°14'x54°58' - 4°36'x3°2'x5°41'	1.0m	M=55 , P=0.75	Ø58.4 x 114.1mm	400g
GMZ11569MCN	11.5-69mm	F1.4-Close	1/2" 31°1'x23°6'x38°3' - 5°3'x4°0'x6°6'	1.0m	M=46 , P=0.75	Ø58 x 113mm	420g
GMZ16100MCN	16-100mm	F1.9-Close	1" 43°6'x33°4' - 7°3'x5°5'	1.1m	M=58 , P=0.75	Ø62.8 x 123.6mm	620g

## Three Motorized Zoom Lenses (Motorized Zoom , Motorized Focus , Motorized Iris)

Item No.	Focal Length	Iris Range	Angle of View (HxVxD)	M.O.D	FilterThread	Dimension (WxHxL)	Weight
GAZ8048010M	8-48mm	F1.0-Close	1/2" 43°6'x33°4' - 7°7'x5°7'	1.0m	M=52 , P=0.75	70x60x98mm	500g
GAZ80800M	8-80mm	F1.2-Close	1/2" 43°6'x33°4' - 4°6'x3°4'	1.2m	M=62 , P=0.75	80x70x130mm	700g
GAZ65104M	6.5-104mm	F1.4-Close	1/2" 52°4'x40°5' - 3°5'x2°6'	1.5m	M=86 , R=1.0	125x100x160mm	1500g
GAZ1025018M	10-250mm	F1.8-Close	1/2" 37°3'x27°7' - 1°5'x1°1'	2.5m	M=86 , R=0.1	110x100x200mm	1500g
GAZ11569M	11.5-69mm	F1.4-Close	2/3" 41°9'x32° - 7°3'x5°5'	1.0m	M=52 , P=0.75	70x60x105mm	500g
GAZ10100M	10-100mm	F1.4-Close	2/3" 47°5'x36°5' - 5°0'x3°8'	1.2m	M=62 , P=0.75	80x70x125mm	700g
GAZ95152M	9.5-152mm	F1.8-Close	2/3" 49°7'x38°3' - 3°3'x2°5'	1.0m	M=86 , P=1.0	125x100x175mm	1500g
GAZ16160M	16-160mm	F2.2-Close	1" 43°4'x32°9'x53°4' - 4°6'x3°5'x5°7'	1.5m	M=67 , P=0.75	118x91x165mm	1320g

## Accessories

Item No.	
E15X	1.5x EXTENDER
E20X	2.0x EXTENDER
E30X	3.0x EXTENDER
E40X	4.0x EXTENDER
EXT-SET	EXTENTION TUBE SET (0.5mm , 1mm , 2mm , 5mm , 10mm , 15mm , 20mm , 25mm , 30mm , 40mm , 50mm , 100mm)
CSAR	CS ADAPTET RING

\*Specifications are subject to change without prior notice

## Standard Manual Lenses

GM23514MCN

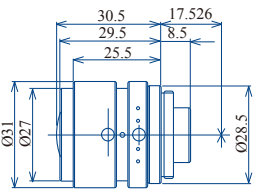

GM23514MCN-1

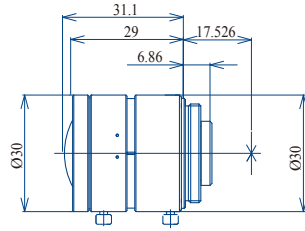

GM24514MCN

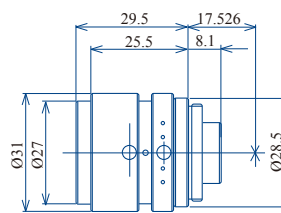

GM26014MCN

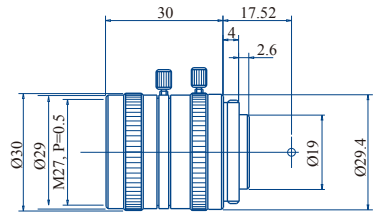

GM36014MCN-1

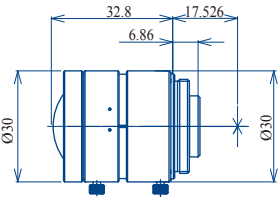

GM38013MCN

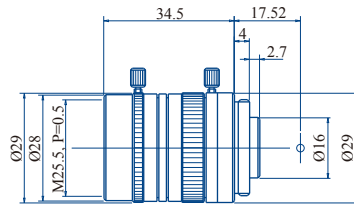

GMN38014MCN-1

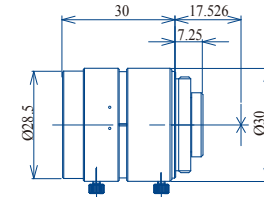

GM21214MCN

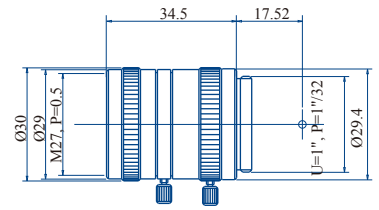

GMN31214MCN-1

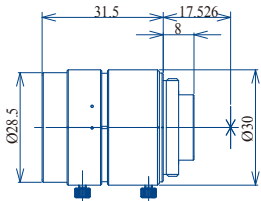

GM31614MCN

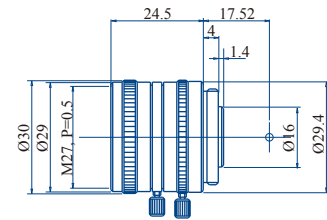

GMN31614MCN-1

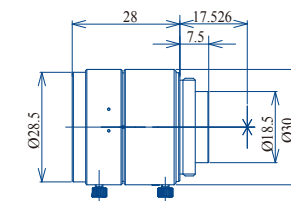

GM32514MCN

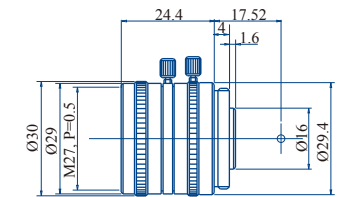

GMN32516MCN-1

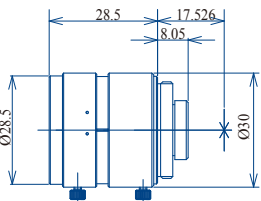

GM23512MCN

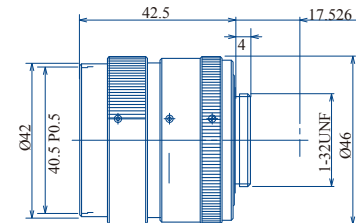

GM33519MCN

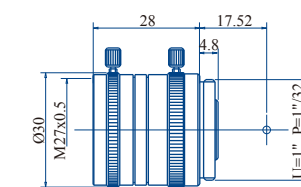

GMN33516MCN-1

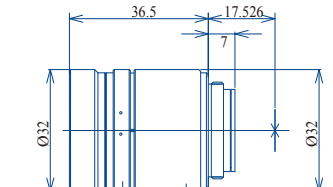

GM35018MCN

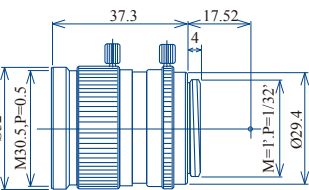

GMN35020MCN-1

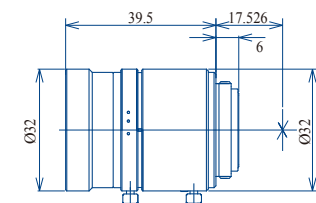

GMT35018MCN

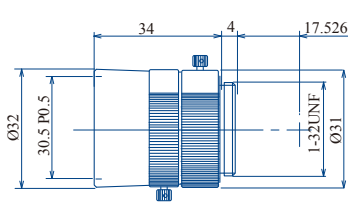

GM37527MCN

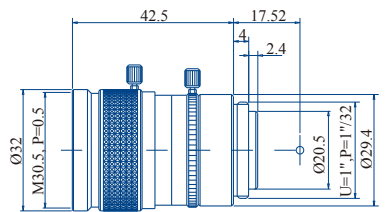

GMN37525MCN-1

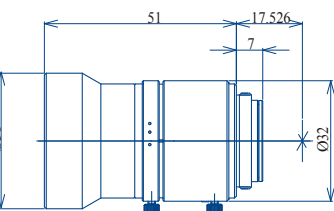

GM310035MCN

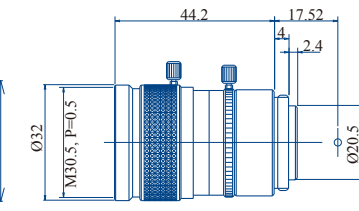

GMN310028MCN-1

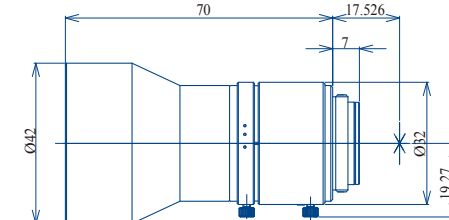

## High Resolution Lenses (for the Megapixel Cameras)

GMHR23524MCN

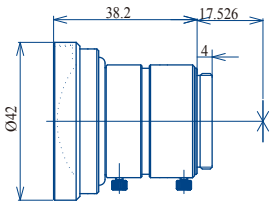

GMHR26012MCN

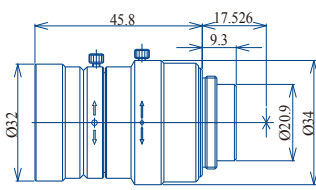

GMHR26014MCN

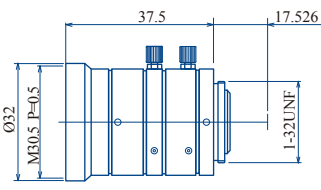

GMTHR21614MCN

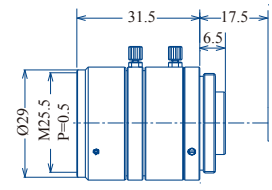

GMHR350528MCN

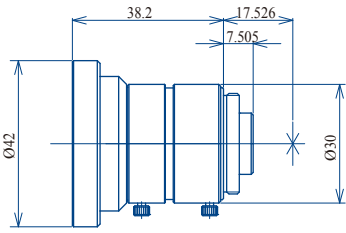

GMHR38014MCN

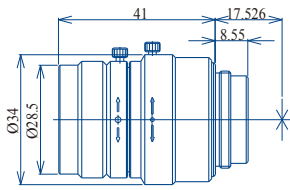

GMHR31214MCN

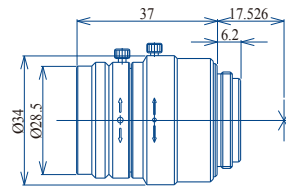

GMHR31614MCN

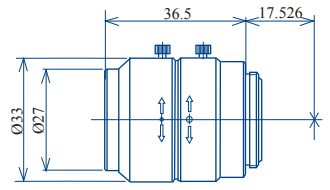

GMHR32514MCN

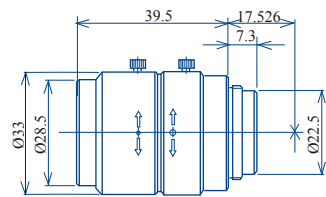

GMTHR32514MCN

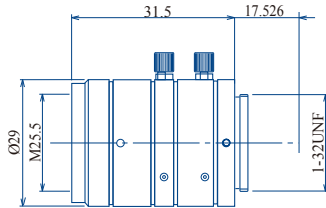

GMHR33520MCN

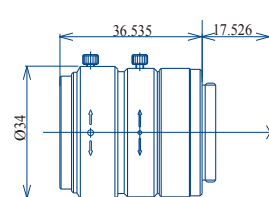

GMTHR33520MCN

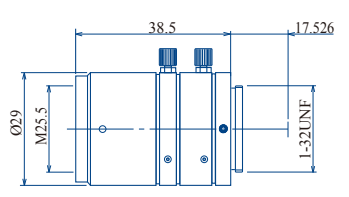

GMHR35028MCN

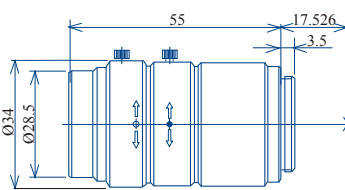

GMTHR35028MCN

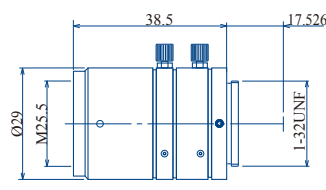

GMG47518MCN

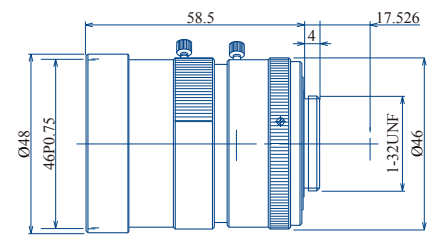

## 1 Inch Format Lenses

GM42514MC

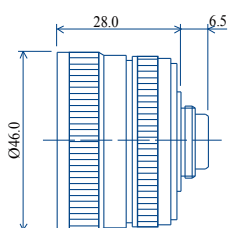

GMG42514MCN

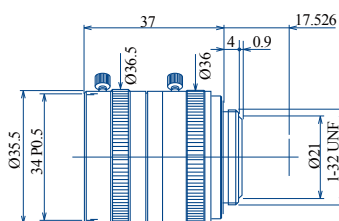

GM45018MC

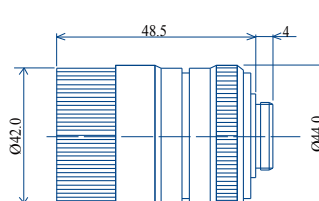

GMG45018MCN

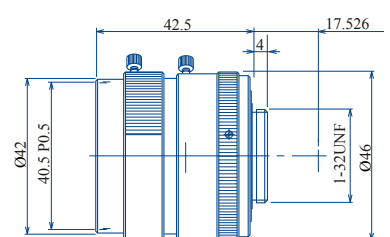

## 1 inch format for high resolution Lenses

GMHR48014MCN

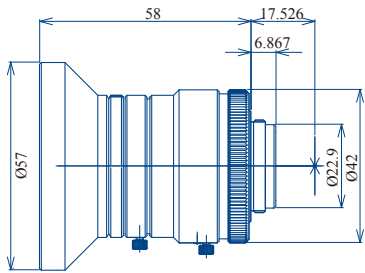

GMHR412513MCN

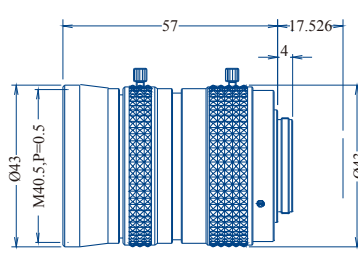

GMHR412514MCN

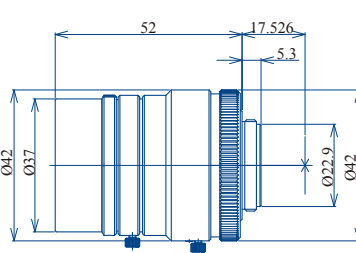

GMHR41614MCN

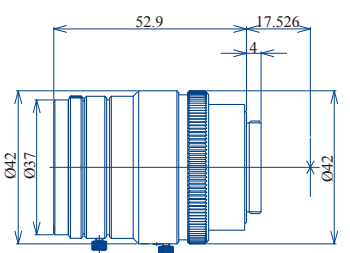

GMHR42514MCN

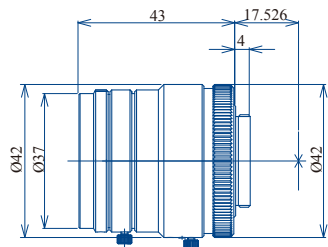

GMHR43514MCN

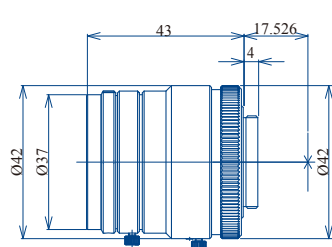

GMHR45013MCN

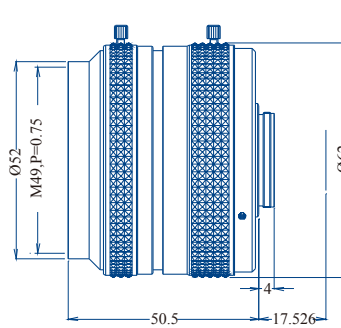

GMHR45014MCN

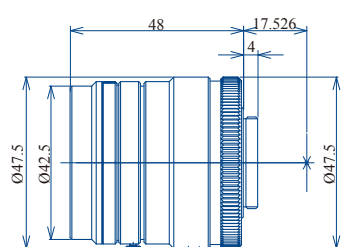

GMHR47518MCN

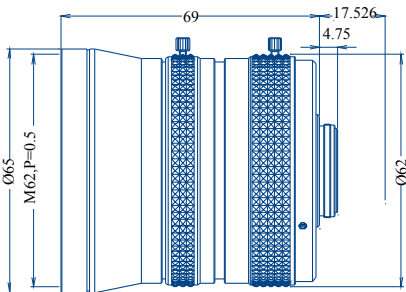

GMHR47518MCN

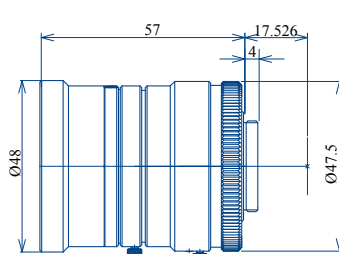

GMMPZ20100MCN

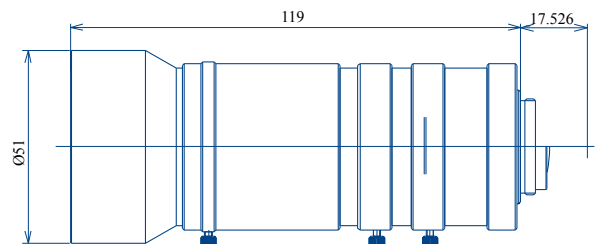

## High Resolution Megapixel Varifocal zoom Lenses

GMMPZ4411MCN

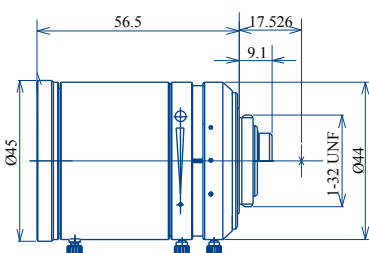

GMMPZ1040MCN

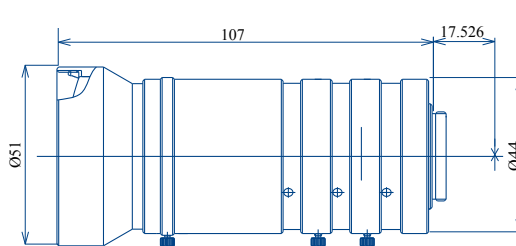

GMMPZ1664MCN

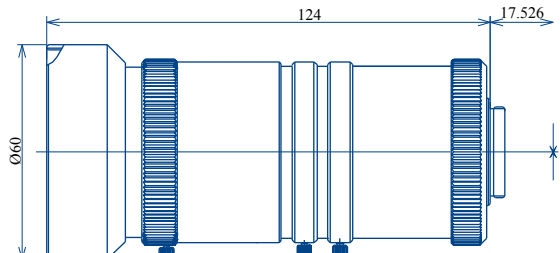

## High resolution 10megapixel, 5megapixel Lenses

GM10HR31218MCN

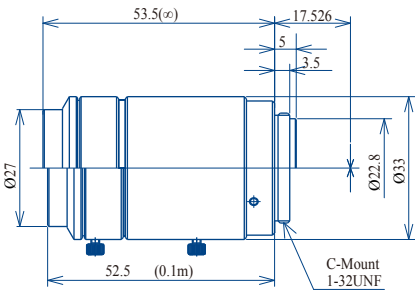

GMB5HR38014MCN

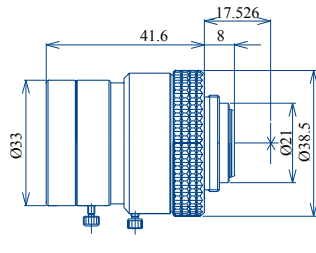

GMA5HR38028MCN

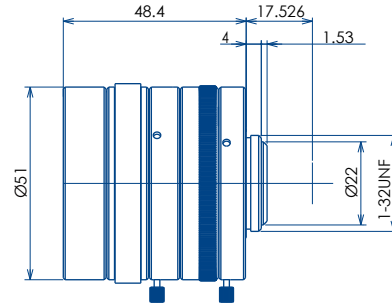

GM5HR39014MCN

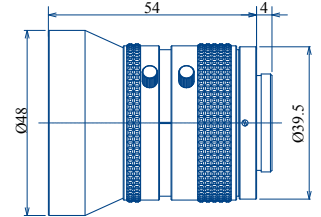

GMB5HR32514MCN

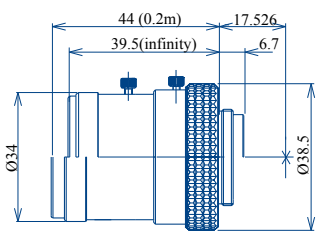

GM5HR31614MCN

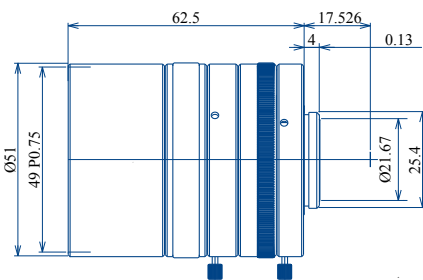

GMB5HR30528MCN

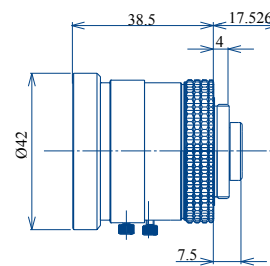

GMB5HR35028MCN

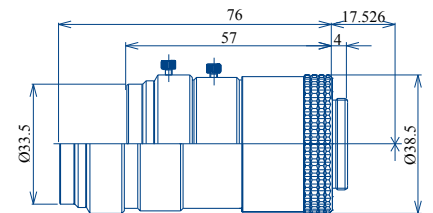

GMB5HR31614MCN

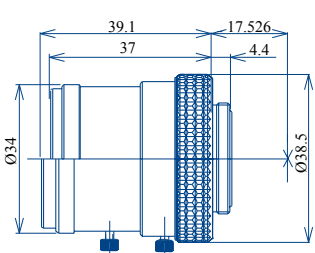

GMA5HR31218MCN

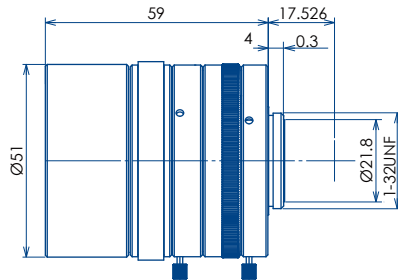

GM5HR32514MCN

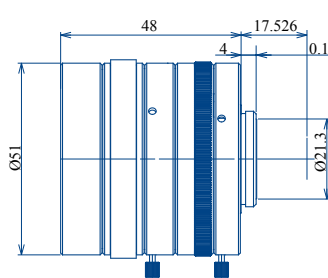

GM5HR33514MCN

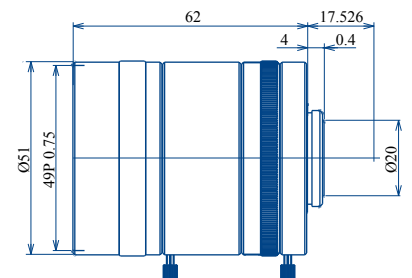

## F0.95 Lenses

GMY31795MC

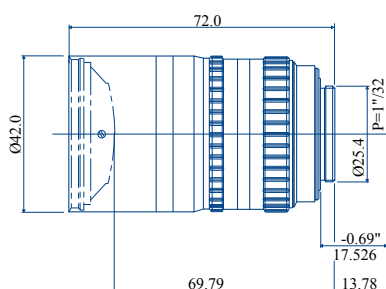

GMY42595MC

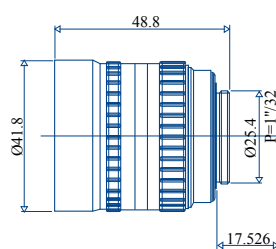

GMV42595MC

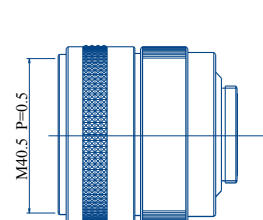

GMY45095MC

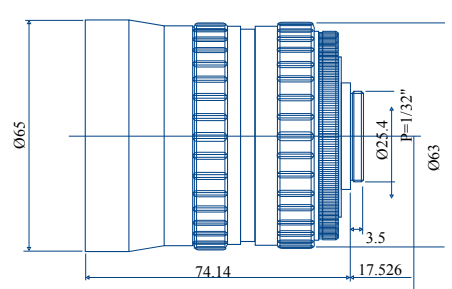

## Manual Vari-Focal Zoom Lenses

GM16539MSN

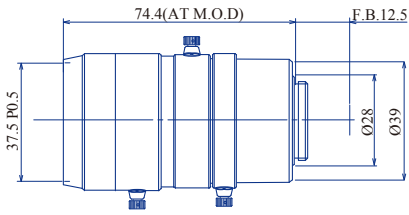

GM50100MSN

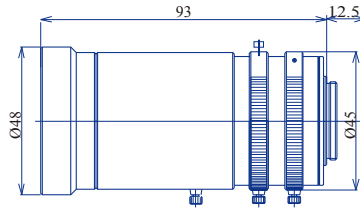

GM26012MCN

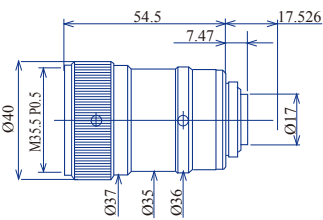

GM26015MCN

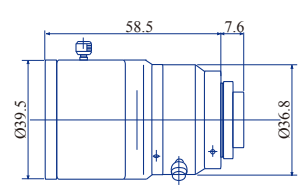

GM26652MCN

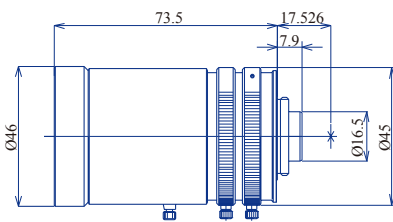

GM28551MCN

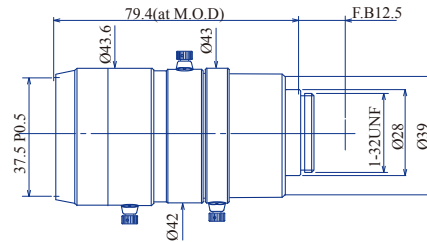

GM29090MCN

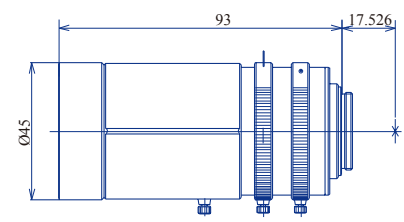

## Manual Zoom Lenses

GMZ8590056MCN

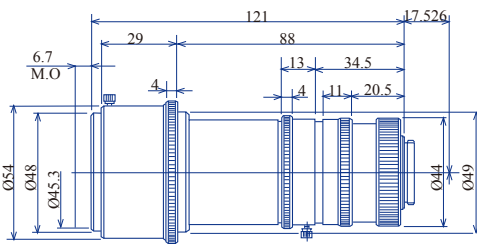

GMZ85900MCN

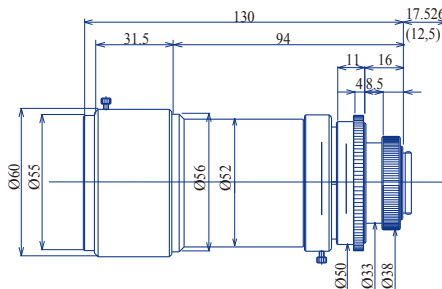

GMZ16100MCN

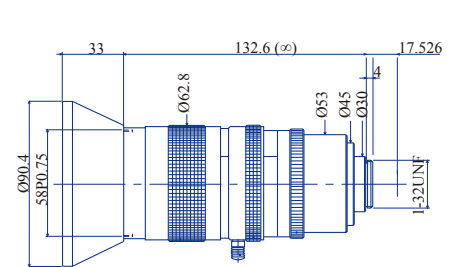

GMZ135108

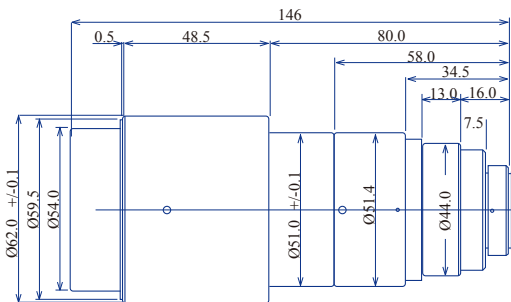

GMZ8048010MCN

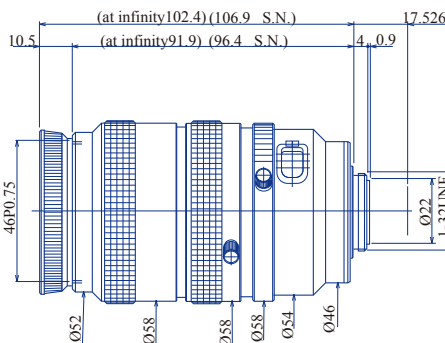

GMZ11569MCN

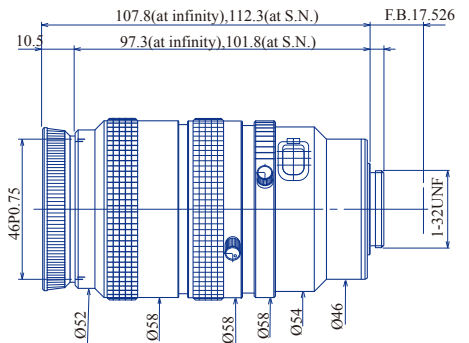

GMZ80800MCN

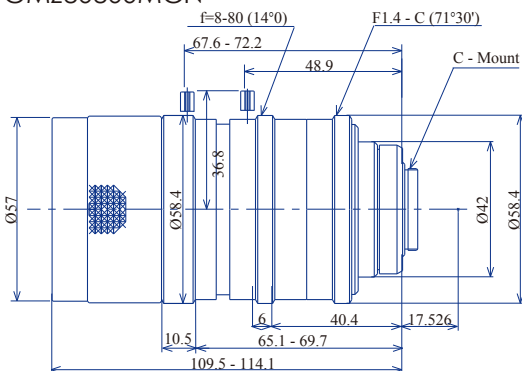

GMZ18108

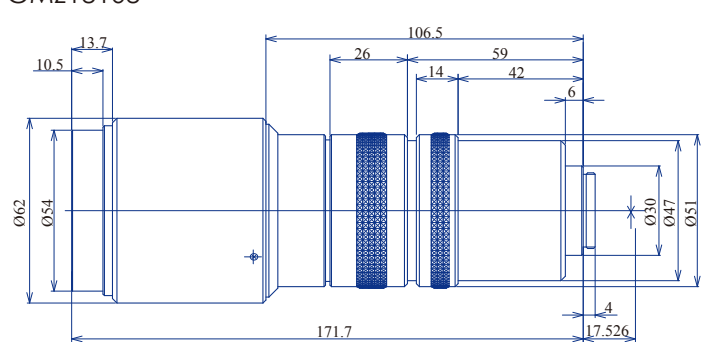

## Three Motorized Zoom Lenses (Motorized Zoom , Motorized Focus , Motorized Iris)

GAZ8048010M

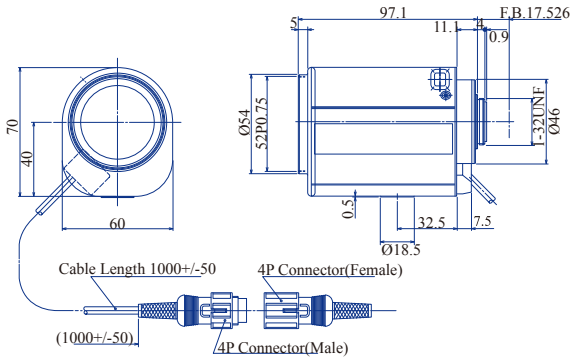

GAZ80800M

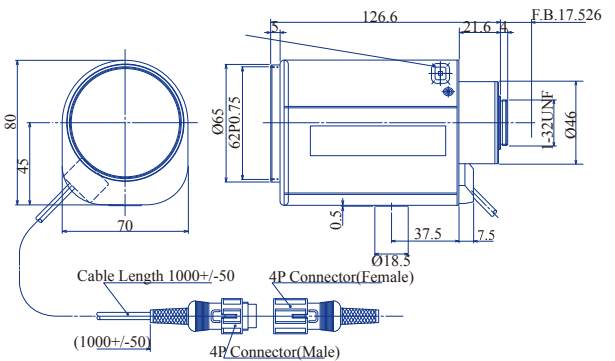

GAZ65104M

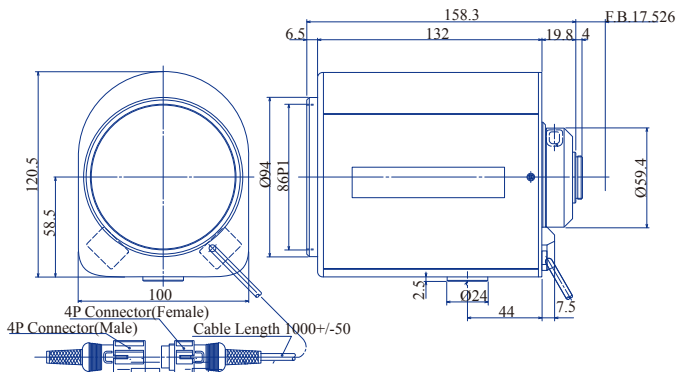

GAZ1025018M

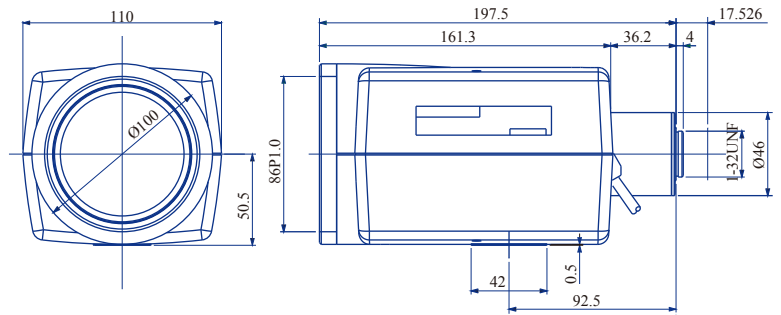

GAZ11569M

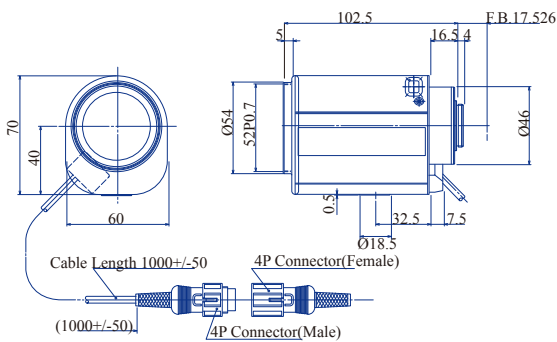

GAZ95152M

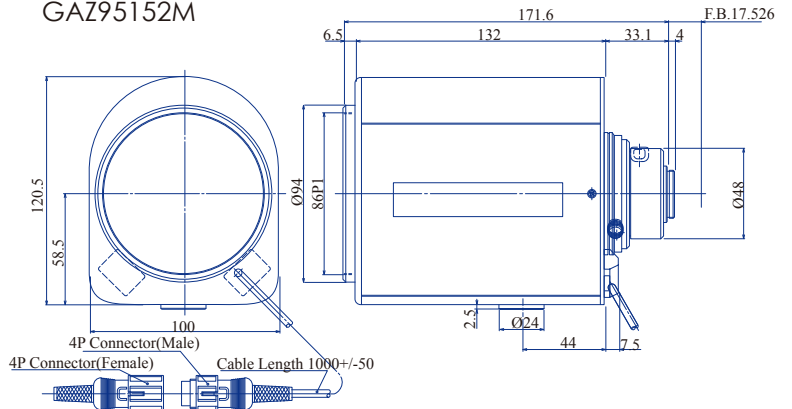

GAZ10100M

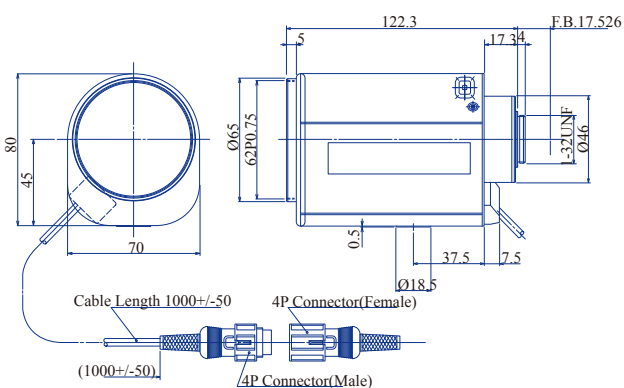

GAZ16160M

